

WASHLET

WHERE HYGIENE
MEETS COMFORT.



OUR TECHNOLOGIES

WASHLET technologies



Warm water rinse

Individually regulated self-cleaning wand jet system



Heated seat

Individually regulated temperature



Deodoriser

Air-cleaning filter



Dryer

Warm air jet



PreMist

Mist of water sprayed onto the ceramic before the toilet is used. Makes it more difficult for dirt and waste to accumulate



Actilight

When combined with UV light, this zirconium coating has antibacterial properties and breaks down waste



ewater+

Electrolysed water with an antibacterial and cleansing effect

Conserve resources



Water-saving

Technology that conserves water

Hygiene technologies



Tornado Flush

Highly effective two- or three-jet toilet flush



CeFiONtect

Special glaze with an extraordinarily smooth ceramic surface for unparalleled hygiene



Rimless design

Ceramic toilet bowl without a rim

Comfort technologies



Auto functions

Sensor-activated technologies

WASHLET

WHERE HYGIENE MEETS COMFORT.

WASHLETS

NEOREST AC	12
NEOREST EW	14
SG	16
GIOVANNONI	18
GL 2.0	20
EK 2.0	22
CF	24

FUNCTIONS

CLEANING FUNCTIONS	28
HYGIENE FUNCTIONS	32
COMFORT FUNCTIONS	38
TOILET FUNCTIONS	40
ECO FUNCTIONS	44
OVERVIEW OF WASHLET FUNCTIONS	46
OVERVIEW OF TECHNICAL DATA	48
PLANNING DATA	50
WHAT YOU SHOULD KNOW	52

35 YEARS OF EXPERIENCE. FOR HYGIENE AND COMFORT

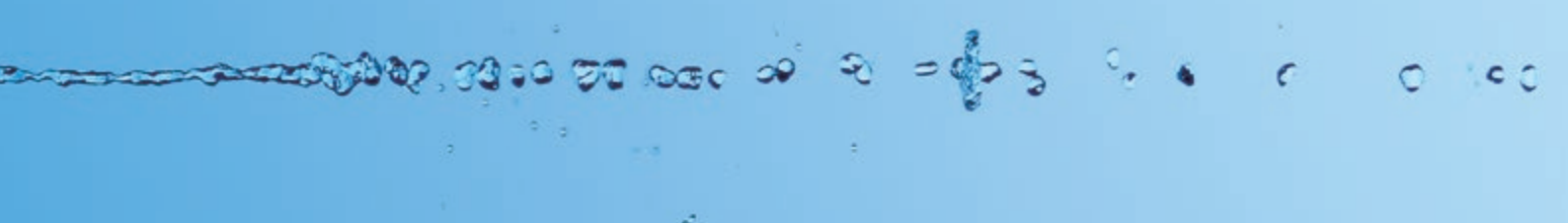

SOPHISTICATED TECHNOLOGY

TOTO has been producing WASHLETs longer than any other company, selling 33 million around the world so far. The WASHLET quickly gained popularity after being introduced in the 1980s. Today, WASHLETs are found in 65 % of Japanese households.

This legacy gives our customers the confidence that TOTO WASHLETs have developed far past the prototype stage. Our WASHLETs are the product of over 30 years of expertise and represent the most advanced WASHLET technology available on the market.

MORE THAN JUST A SHOWER TOILET OUR PRINCIPLE

Bathing culture has always played a major role in Japanese tradition, which is why this nation has such high standards for hygiene and comfort in the bathroom.

As the market leader in Japan, TOTO constantly works to improve its products – and has succeeded tremendously with the WASHLET. The WASHLET provides a very comfortable means of enhancing personal hygiene. At the same time, the WASHLET itself is extremely hygienic, featuring self-cleaning parts or technologies that make it difficult for dirt or waste to accumulate.

CLEAN TECHNOLOGY SINCE 1917



o o o

o o

o o o

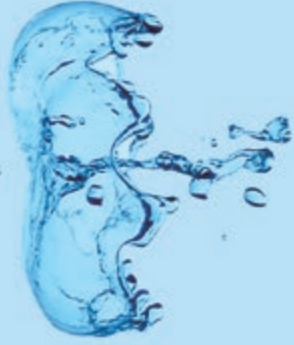

o

WASHLET

FOR THE ULTIMATE FEELING OF CLEAN.

THE BENEFITS OF CLEANSING WITH WATER.

Part of Japanese lifestyle for years, the WASHLET is still new to Europeans.

Cleansing with warm water after using the toilet provides an especially clean feeling. The special wand jet system is fully adjustable, allowing users to set the precise temperature, position and spray type for comfortable intimate cleansing. All easily soiled parts of the WASHLET stay clean and hygienic.



WHY A TOTO WASHLET? BECAUSE ONLY TOTO THOUGHT OF EVERYTHING.

- 1. ONLY TOTO OFFERS THE COMBINATION OF THE RIMLESS, HYGIENIC TOILET BOWL, TORNADO FLUSH AND WASHLET.**
- 2. ONLY TOTO HAS A SELF-CLEANING WASHLET.**
- 3. ONLY TOTO USES THE CLEANING AND ANTIBACTERIAL EWATER+ FUNCTION.**
- 4. ONLY TOTO OFFERS A WASHLET WITH SO MANY DIFFERENT WARM WATER CLEANING FUNCTIONS.**
- 5. ONLY TOTO OFFERS INTELLIGENT SURFACE SOLUTIONS, INCLUDING THE CEFIONTECT GLAZE USED ON CERAMICS, AS WELL AS THE SILICONE-BASED MATERIALS USED FOR THE TOILET SEAT AND WAND JET.**
- 6. ONLY TOTO HAS AN IMPRESSIVE 33 YEARS OF WASHLET EXPERIENCE YOU CAN COUNT ON.**

TOTO WASHLETS.

THE IDEAL COMBINATION FOR PERFECT HYGIENE.



Rimless design

Ceramic toilet bowl without a rim



Tornado Flush

Highly effective two- or three-jet flush



CeFiONtect

Special glaze with an extraordinarily smooth ceramic surface for unparalleled hygiene



+ **washLÉT**
TOTO
CERAMIC

= **THE ULTIMATE**
FEELING
OF CLEAN

TOTO
WASHLETS.
HYGIENE AND
COMFORT FOR
EVERY TASTE.

WASHLETS OVERVIEW.

WASHLET NEOREST AC
THE PREMIUM SOLUTION
FOR TOTAL HYGIENE AND
COMFORT.



This WASHLET is self-cleaning. A photocatalytic process breaks down all organic substances in the inside of the toilet bowl, making it practically impossible for waste, bacteria and mould to accumulate.

- ▶ Individually adjustable wand jet p. 28
- ▶ Self-cleaning Actilight function p. 33
- ▶ Antibacterial ewater+ feature p. 33
- ▶ Sensor-activated lid and flush p. 38
- ▶ Heated seat p. 38
- ▶ Dryer p. 38
- ▶ Filter p. 38
- ▶ Energy saver timer p. 45
- ▶ Energy saver auto p. 45

WASHLET NEOREST EW
THE ULTIMATE SOLUTION
WITH ADDED HYGIENE
AND COMFORT.



This WASHLET features integrated ewater+ technology. Once the toilet is flushed, the inside of the bowl is sprayed with electrolysed water. This system, called ewater+ has an antibacterial and cleansing effect for the ultimate in hygiene.

- ▶ Individually adjustable wand jet p. 28
- ▶ Antibacterial ewater+ feature p. 33
- ▶ Sensor-activated lid and flush p. 38
- ▶ Heated seat p. 38
- ▶ Dryer p. 38
- ▶ Filter p. 38
- ▶ Energy saver timer p. 45
- ▶ Energy saver auto p. 45

WASHLET SG
THE ALL-ROUND
SOLUTION WITH
ADDED HYGIENE.



The SG collection WASHLET offers all standard TOTO WASHLET features. In addition to the characteristic warm water spray, odour-absorbing deodoriser and dryer, it has the new ewater+ feature with its antibacterial and cleansing effect.

- ▶ Individually adjustable wand jet p. 28
- ▶ Antibacterial ewater+ feature p. 33
- ▶ Sensor-activated lid p. 38
- ▶ Heated seat p. 38
- ▶ Dryer p. 38
- ▶ Filter p. 38
- ▶ Energy saver timer p. 45
- ▶ Energy saver auto p. 45

WASHLET GIOVANNONI
THE DESIGN SOLUTION.



This WASHLET was designed by Stefano Giovannoni, making this product a unique combination of functional technology and outstanding Italian design. This WASHLET offers all of the standard functions – In a uniquely designed form.

- ▶ Individually adjustable wand jet p. 28
- ▶ Heated seat p. 38
- ▶ Filter p. 38
- ▶ Energy saver timer p. 45

WASHLET GL 2.0
THE SOLUTION WITH
ADDED COMFORTS.



The WASHLET GL 2.0 offers the performance and reliability of all TOTO WASHLETs, including the adjustable spray type, water pressure and temperature. Together with the added convenience of Remote control and air filter system, this WASHLET provides outstanding comfort and performance.

- ▶ Individually adjustable wand jet p. 28
- ▶ Heated seat p. 38
- ▶ Dryer p. 38
- ▶ Filter p. 38
- ▶ Energy saver auto p. 45

WASHLET EK 2.0
BEAUTIFULLY, SIMPLE
AND EASY TO USE.



The WASHLET EK 2.0 fits on all TOTO MH and NC collection toilets and offers all proven WASHLET technologies. The warm water spray ensures that every user leaves clean and fresh, while the control panel makes these technologies easy to use.

- ▶ Individually adjustable wand jet p. 28
- ▶ Heated seat p. 38
- ▶ Dryer p. 38
- ▶ Energy saver auto p. 45



WASHLET NEOREST AC

The NEOREST AC WASHLET is the first completely self-cleaning WASHLET. It features the proven WASHLET technologies and also actively combats dirt and bacteria.

The WASHLET is available in two versions: the NEOREST AC (with Actilight technology) and NEOREST EW (with ewater+ technology). They look the same, but work in different ways. Actilight technology utilises an integrated UV light and zirconium coating to break down bacteria and dirt. The electrolysed ewater+ has an antibacterial and cleansing effect.

The PreMist function helps fight bacteria and dirt from the outset. This sprays the toilet bowl with water before use, making it more difficult for waste to accumulate.

The WASHLET also has a sensor-activated lid which opens and closes by itself, an automatic flush and an adjustable dryer. The heated seat and deodoriser ensure that your visit to the bathroom is more pleasant. The wand jet system for personal cleansing is, of course, individually adjustable and provides unlimited warm water thanks to the continuous-flow water heater integrated in the WASHLET.

Of course, the NEOREST AC toilet seat isn't kept heated at all times. Instead, a memory function records the user's preferences for 10 days. The toilet then switches to energy-saving mode as required.

The water for the NEOREST WASHLET warm water spray is heated by a continuous-flow water heater instead of being stored in an additional tank. This means unlimited warm water for intimate cleansing.

► Planning data p. 50





WASHLET NEOREST EW

The NEOREST EW WASHLET is basically identical to the NEOREST AC – the only difference is that the EW does not feature the self-cleaning Actilight technology.

Before use, the NEOREST EW WASHLET sprays the inside of the toilet bowl with water – after all, less waste will stick to a wet surface. Once the toilet is flushed, the WASHLET sprays the bowl with electrolysed water. This ewater+ has an antibacterial and cleansing effect.

Like the NEOREST AC, the NEOREST EW has a sensor-activated lid which opens and closes by itself, an automatic flush and an adjustable dryer. The heated seat and deodoriser ensure that your visit to the bathroom is more pleasant. The wand jet system for personal cleansing is, of course, individually adjustable. All the functions, including the water jet temperature, pressure and position, can be conveniently adjusted using the remote control.

Of course, the NEOREST EW toilet seat isn't kept heated at all times. Instead, a memory function records the user's preferences for 10 days. The toilet then switches to energy-saving mode as required.

► Planning data p. 50



WASHLET SG

The WASHLET SG offers all the standard features available in all other TOTO WASHLETs. In addition to the characteristic warm water spray, the WASHLET has a heated seat, an odour-absorbing deodoriser, dryer, and the ewater+ function. This feature sprays the toilet bowl with electrolysed water. The anti-bacterial ewater+ actively breaks down waste.

Instead of being stored in an additional tank, the water for the WASHLET SG warm water spray is heated by a continuous-flow water heater. This means unlimited warm water for intimate cleansing.

► Planning data p. 50







GIOVANNONI

This WASHLET is the product of an international design partnership between TOTO and renowned Italian designer Stefano Giovannoni, uniquely combining functional technology and high-quality Italian design. The Giovannoni WASHLET cleverly hides many of the unique features you'd expect from a TOTO WASHLET. It features the self-cleaning wand jet,

warm water spray, heated seat, air cleaning function and remote control to make hygiene and comfort natural aspects of your bath. The rimless design, Tornado Flush and special CeFiONtect glaze make this WASHLET complete – making it more than just a beautiful design object for your bathroom.

► Planning data p. 50



WASHLET GL 2.0



The WASHLET GL 2.0 can be combined with the TOTO NC and MH toilets.

The WASHLET GL 2.0 features all TOTO comfort technologies, including the adjustable warm water spray, temperature control, different types of sprays, a heated seat, a deodorizer, and drying function. Two users can save preferred settings and activate them at the touch of a button using the remote control.

The toilet bowl is sprayed with water before use, which makes it more difficult for dirt and waste to accumulate.

When not used for extended periods of time, the WASHLET GL 2.0 automatically switches to energy-saving mode.

► Planning data p. 50





WASHLET EK 2.0



The WASHLET EK 2.0 is compatible with the NC and MH series toilets. Users can activate all functions using the side control panel. It is possible to choose the temperature and type of the warm water spray, set the seat temperature and activate the dryer function. The WASHLET EK 2.0 learns the habits of its users and automatically switches to energy-saving mode on this basis. Like all TOTO WASHLETs, it also has an automatic, sensor-activated seat.

► Planning data p. 50



WASHLET CF



The WASHLET CF fits on the CF series toilets, as well as most other conventional toilet bowls.

It is easy to activate all functions by remote control, including the type and temperature of the warm water spray for intimate cleansing.

This model also has a dryer, a filter system to fight unpleasant odours, and automatically switches to energy-saving mode when not in use for extended periods of time.

► Planning data p. 50



WASHLET
FUNCTIONS.
CLEANSING,
HYGIENE
AND COMFORT
IN ONE.

CLEANSING FUNCTIONS EVERYONE HAS DIFFERENT NEEDS.

WARM WATER SPRAY.



Comfort spray

The comfort spray is designed to clean the rear intimate area. The water jet features pleasant, yet strong water pressure to target this specific area. The result: thorough cleansing without unnecessary splashing.



Soft comfort spray

This type of spray is also designed to clean the rear intimate area. It has a larger radius to cover more space. Low water pressure makes for a soft, comfortable spray.



Front Wash

The front wash consists of large, soft drops for comfortable intimate cleansing – for a clean, fresh feeling.



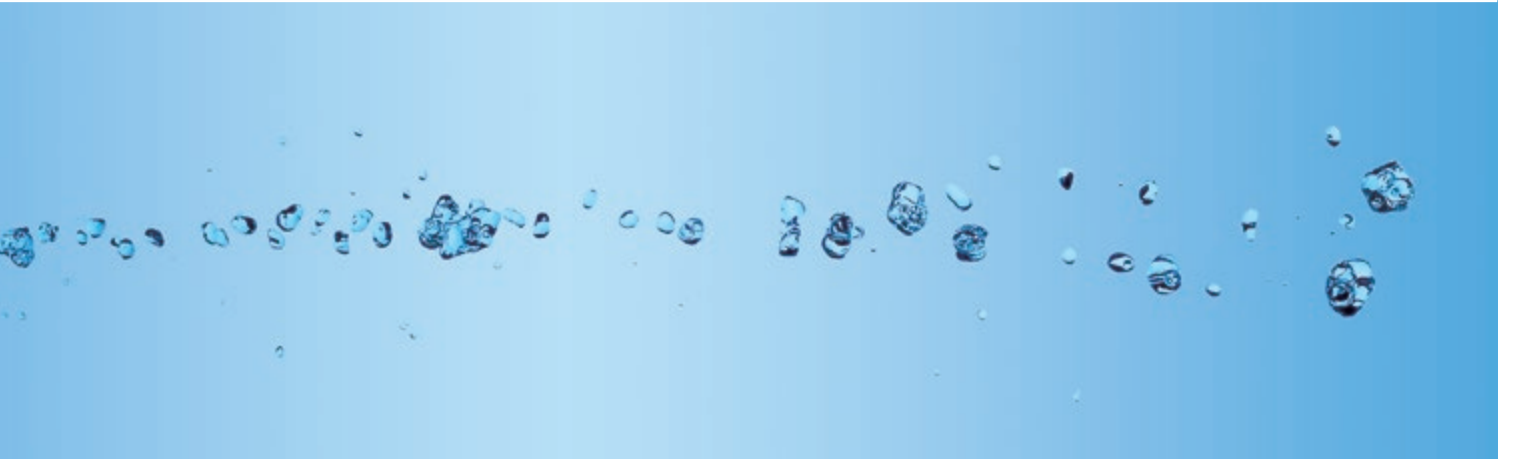

CLEANSING FUNCTIONS EVERYONE HAS DIFFERENT NEEDS.

WARM WATER SPRAY.



Oscillating comfort spray

The oscillating comfort spray can be activated in addition to the other spray types. The wand jet moves in and out for especially thorough cleansing over larger areas – for a feeling of ultimate clean.



Massage spray

You can also choose the massage function. The water pressure switches automatically between soft and hard.



Adjustable water pressure

The water pressure of the spray can be adjusted in five levels to meet the needs of each user.



Adjustable position

The position of the wand jet can be adjusted and adapted as required for each user – because everyone's different.



Continuous-flow water heater

Our NEOREST AC, EW and SG WASHLETs feature a continuous-flow water heater to provide unlimited water for intimate cleansing.

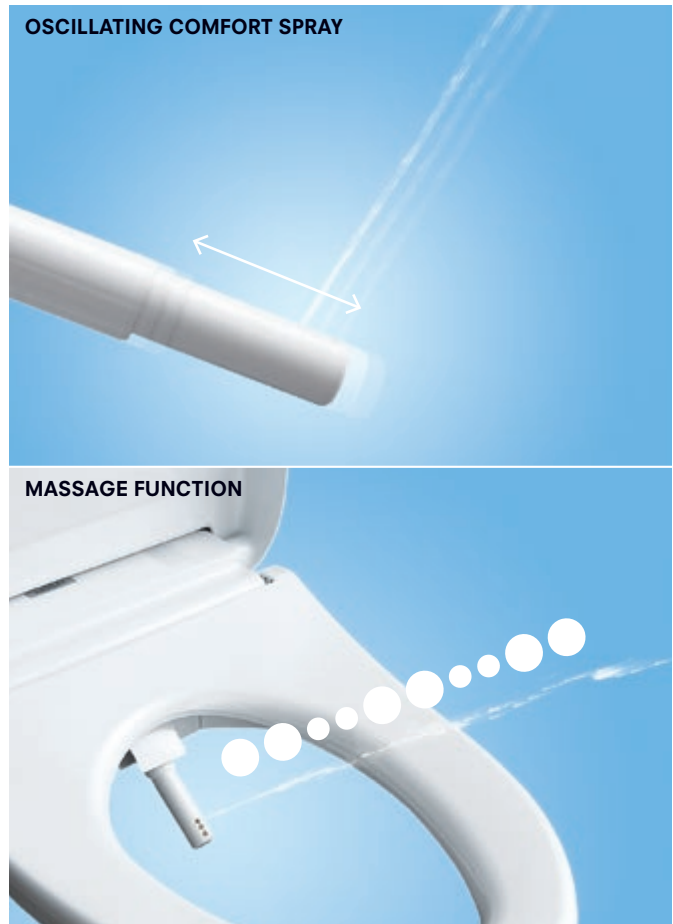





HYGIENE FUNCTIONS

PREMIST, EWATER+ UND ACTILIGHT

PreMist

The PreMist function ensures the greatest possible hygiene from the very first moment. The toilet bowl is sprayed with water prior to use. This fine film of water over the CeFiONtect glaze helps eliminate dirt and waste 80% better with each flush. This makes the toilet easier to clean without the need for aggressive cleansers, and improves overall hygiene.

Actilight

The self-cleaning toilet bowl uses a photocatalytic process, which requires two components – UV light and the special zirconium coating. This is why the NEOREST AC features a UV light integrated into the lid of the toilet bowl. This automatically switches on once the sensor-activated lid is closed. The combination of UV light and zirconium coating breaks down all organic substances in the toilet bowl – the toilet truly cleans itself.

ewater+

The WASHLET sprays the toilet bowl with a fine mist of water prior to use because less waste and dirt will cling to a wet surface than a dry one. Once the toilet has been flushed, the WASHLET sprays the toilet bowl with electrolysed ewater+, which has an antibacterial and cleansing effect. It is absolutely safe for the environment and can be returned to the water cycle without worry.



HYGIENE FUNCTIONS

PREMIST, EWATER+ UND ACTILIGHT

PREMIST

The PreMist function ensures the greatest possible hygiene from the very first moment. The toilet bowl is sprayed with water prior to use. This fine film of water over the CeFiONtect

glaze helps eliminate dirt and waste 80% better with each flush. This makes the toilet easier to clean without the need for aggressive cleansers, and improves overall hygiene.

EWATER+

The WASHLET initially sprays the toilet bowl with regular water, and then with electrolysed water following use. ewater+ has an antibacterial and cleansing effect.

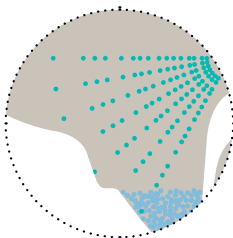
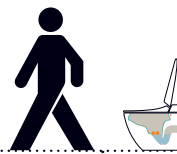
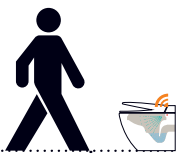

1. The sensor-activated lid lifts automatically. The ceramic is sprayed with regular water prior to use (PreMist).

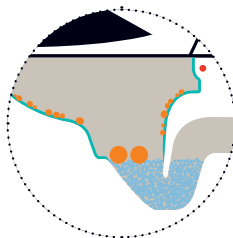

2. The water film makes it difficult for dirt and waste to stick to the surface. The deodoriser is activated.

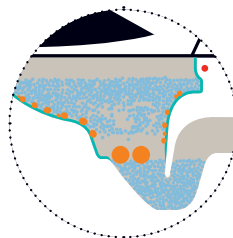

3. The Tornado Flush effectively cleans the toilet with a powerful whirlpool of water from three jets.

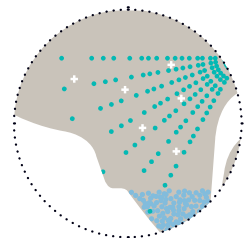

4. After use, the WASHLET sprays the bowl with electrolysed ewater+. This has an antibacterial and cleansing effect.

ACTILIGHT

The combination of zirconium-coated ceramic and UV light triggers a photocatalytic process that completely destroys waste and bacteria. The toilet literally cleans itself.

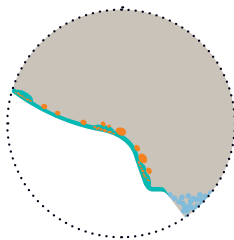

5. The ceramic features a special zirconium coating, which is especially durable and hydrophilic. Water easily washes away and eliminates the waste.

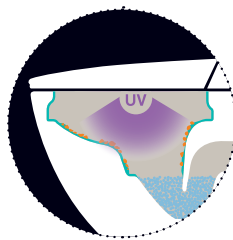

6. Once the toilet lid is closed, the integrated UV light turns on for an hour.

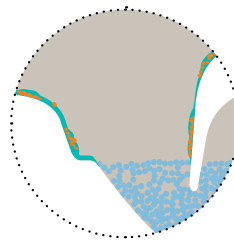

7. The interplay of the special coating and UV light releases activated oxygen, which breaks down waste without attacking the surface – a process that is completely safe for the environment.

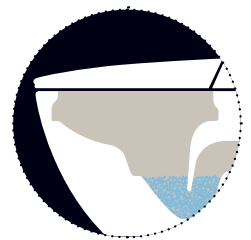

8. The Actilight function makes the toilet completely self-cleaning. If the toilet is not in use for eight hours, the WASHLET automatically sprays the bowl with ewater+ and the UV light in the lid switches on.

HYGIENE FUNCTIONS

IMPROVED HYGIENE FOR GREATER COMFORT.

Self-cleaning wand jet

The WASHLET automatically cleans the wand jet before and after each use. The TOTO WASHLET wand jets are made of a material containing silicone, which makes them both antibacterial and extremely resistant to dirt. It is extremely difficult for anything to stick to the wand jet when wet – making it impossible for waste to accumulate. Thanks to this feature, TOTO is able to clean its wand jet system using only water – without any chemical additives. This also makes the system maintenance-free – the WASHLET does not need to be filled with substances to clean the jet.

The ewater+ WASHLET models use regular and antibacterial ewater+ to clean the wand jets.

Wand jet position

The jet extends at an angle, which keeps it from getting dirty. The soiled water falls directly into the toilet bowl at an angle of 43–53°, which keeps the jet clean.



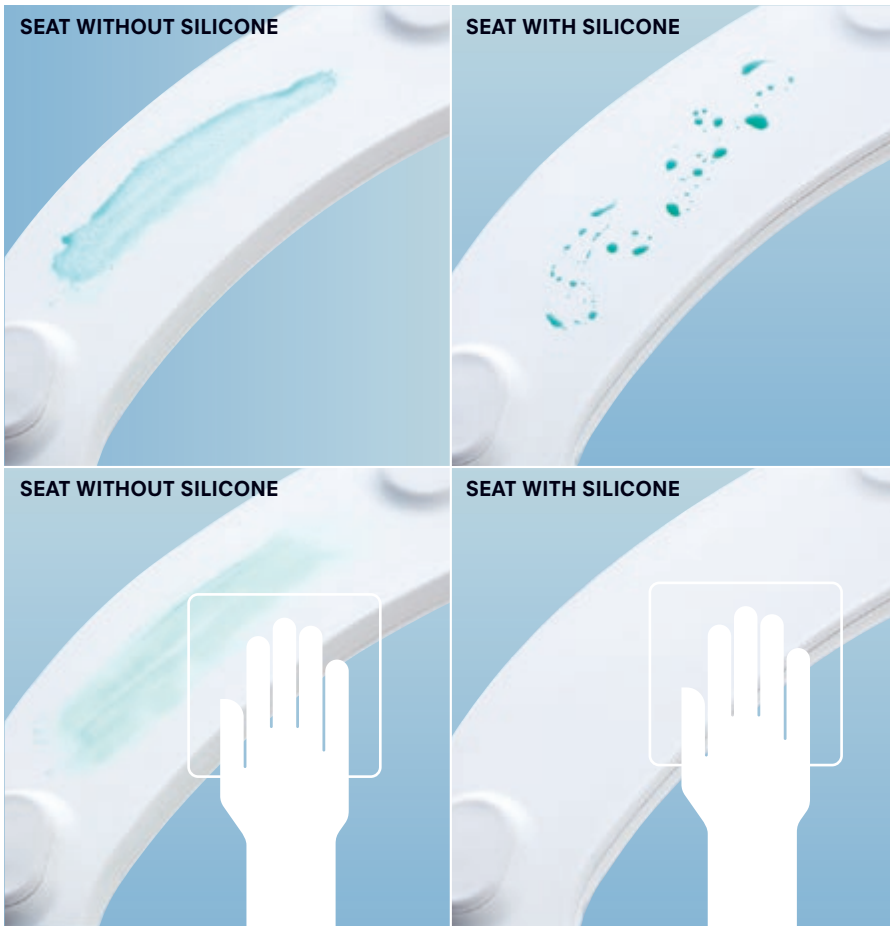

Clean toilet seat

The toilet seat also consists of a special silicone-based material with dirt-resistant properties. The top and bottom of the toilet seat is coated with a dirt-resistant silicone alloy – for easier cleaning that lasts longer.

COMFORT FUNCTIONS

YOUR WELL-BEING IS OUR TOP PRIORITY.

EASY AND CONVENIENT TO USE.

Sensor-activated features

The sensor-activated lid opens automatically when someone nears the WASHLET and closes after use. The NEOREST WASHLETs also have a sensor-activated flush.

Heated seat

The heated seat can be set to the desired temperature.

Remote control

The remote control makes all functions easy to use and adjust. Several models include a memory function to save preferred settings for up to two users.

Dryer

The individually adjustable dryer follows the warm water spray to ensure a dry, clean overall feeling.

Deodoriser

The deodoriser effectively cleans the air around the toilet using powerful filters. Air is drawn in, passing through an ionised carbon filter to eliminate unpleasant odours.

Side night lights

People who do not want to turn on the bright bathroom light at night can choose a model featuring nightlights on the sides. A soft light on the sides of the toilet provides enough brightness to see and also helps people fall asleep again more quickly.

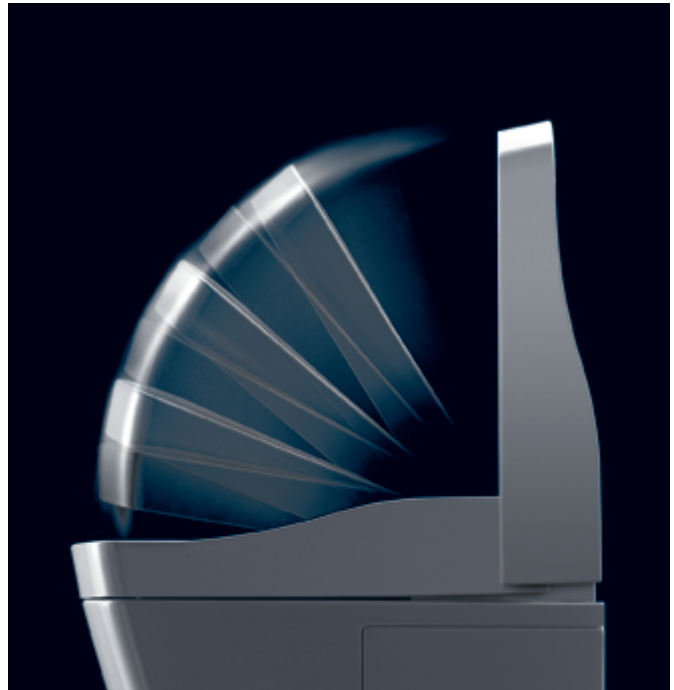





TOILET FUNCTIONS

PERFECT HYGIENE IS THE TOTO STANDARD.

BENEFITS OF TOTO CERAMIC.

Tornado Flush

An important feature of every TOTO toilet is the Tornado Flush. Three jets create a powerful whirlpool of water in the toilet bowl, like a tornado, effectively cleaning every inch. The power of the water is bundled and strengthened in a single direction. No spot in the toilet bowl is left untouched. As a result, it is practically impossible for bacteria, germs and waste to accumulate.

HYGIENE, SETTING NEW STANDARDS.

Hygiene report

TOTO commissioned a comparative study* of a conventional toilet and the TOTO toilets with Tornado Flush.

The results showed that these TOTO toilets are especially suitable for use in hygiene-critical areas, such as hospitals, care facilities and heavily used toilets.

Another finding showed that the Tornado Flush on the rimless TOTO toilet eliminated all waste and organisms from the surface with the very first flush.

To read the complete report, go to:
<http://gb.toto.com>

“IT WAS POSSIBLE TO THOROUGHLY CLEAN THE CERAMIC SURFACE AND ELIMINATE ALL SOILED AREAS ON THE CERAMIC SURFACES OF THE TOTO TOILETS QUICKLY, EASILY AND WITHOUT GREAT EFFORT. FOR THIS REASON, ONLY VERY LITTLE TIME IS NEEDED FOR CLEANING.”

“ ...THE TOTO CW762Y AND CW132Y RIMLESS TOILETS [...] ARE SUPERIOR TO THE CONVENTIONAL TOILET WITH RIM AND STANDARD FLUSH.”

Prof. Dr. med. Klaus-Dieter Zastrow
Doctor for hygiene and environmental medicine

TOILET FUNCTIONS

PERFECT HYGIENE IS THE TOTO STANDARD.

BENEFITS OF TOTO CERAMIC.

Rimless design

Rimless toilet bowls are a standard feature of all TOTO toilets. As a result, there are no difficult-to-reach areas below the edge in which bacteria and waste can accumulate, for quicker, easier and more thorough cleaning.

CeFiONtect glaze

All TOTO ceramics are treated with the extremely durable and smooth CeFiONtect glaze. While conventional ceramics are normally coated (not glazed) and still have a rough surface, CeFiONtect provides an outstanding level of hygiene – making it practically impossible for dirt, waste and mould to accumulate. CeFiONtect-glazed surfaces can be cleaned using micro-fiber cloths without eroding the glaze over time.

Hygiene Certificate

TOTO's ceramic toilet technologies have been recognised with the German Hygiene Certificate.





TOTO

NEOREST



ECO FUNCTIONS

FOR THE ENVIRONMENT AND SAFE DRINKING WATER



No chemical cleansers

All TOTO WASHLETs wands are self cleaning, using high pressure water jets, therefore they require no chemical additives for cleaning. Since the WASHLET uses only pure water for cleaning, it is not necessary to add any chemicals. This also makes the system maintenance free – the WASHLET does not need to be filled with chemical substances. The ewater+ WASHLET models use regular and antibacterial ewater+ to clean the wand jets – and require no maintenance.

Energy savers

TOTO WASHLETs feature two types of energy savers. Energy saver timer allows you to set a time at which the WASHLET is set to stand-by mode. With energy saver auto, the WASHLET records its users' habits and automatically selects the best time for stand-by mode.

EN 1717

standard for drinking water safety

Toilet water is rated as a hazard class 5 liquid in accordance with EN 1717. This standard describes the necessary precautions that a device must fulfil in order to secure the quality of drinking water. All TOTO WASHLETs are intrinsically safe and have a family A, type B backflow prevention device in line with DIN EN 13077. This keeps non-potable water from flowing back into drinking water systems without any additional installation required.

OVERVIEW OF WASHLET FUNCTIONS

		NEOREST AC	NEOREST EW	
REINIGUNGSFUNKTIONEN	 COMFORT SPRAY REAR	•	•	
	 COMFORT SPRAY REAR SOFT	•	•	
	 COMFORT SPRAY FRONT WASH	•	•	
	 OSCILLATING COMFORT SPRAY	•	•	
	 MASSAGE SPRAY	•	•	
	 ADJUSTABLE WATER PRESSURE	•	•	
	 ADJUSTABLE POSITION	•	•	
HYGIENEFUNKTIONEN	 ACTILIGHT	•		
	 EWATER+	•	•	
	 PREMIST	•	•	
	 SELF-CLEANING WAND JET	•	•	
	 SELF-CLEANING WAND JET WITH EWATER+	•	•	
	 DEODORISER – AIR-CLEANING FILTER SYSTEM	•	•	
	 WAND JET MATERIAL KEEPS DIRT FROM ACCUMULATING *	•	•	
	 CEFIONTECT GLAZE	•	•	
	 RIMLESS DESIGN	•	•	
	 TORNADO FLUSH	•	•	
 SEAT MATERIAL KEEPS DIRT FROM ACCUMULATING *	•	•		
KOMFORTFUNKTIONEN	 NIGHTLIGHT	•	•	
	 SENSOR-ACTIVATED LID	•	•	
	 SENSOR-ACTIVATED FLUSH	•	•	
	 SOFT-CLOSING SEAT			
	 REMOTE CONTROL	•	•	
	 DRYER WITH ADJUSTABLE TEMPERATURE	•	•	
	 HEATED SEAT WITH ADJUSTABLE TEMPERATURE	•	•	
	 MEMORY FUNCTION FOR TWO PEOPLE	•	•	
	 CONTINUOUS-FLOW WATER HEATER	•	•	
ECO	 ENERGY SAVER TIMER	•	•	
	 ENERGY SAVER AUTO	•	•	
	 NO CHEMICAL CLEANERS REQUIRED	•	•	

* silicone-based alloy

WASHLET SG



GIOVANNONI



WASHLET GL 2.0



WASHLET EK 2.0



WASHLET CF



•

•

•

•

•

•

•

•

•

•

•

•

•

•

•

•

•

•

•

•

•

•

•

•

•

•

•

•

•

•

•

•

•

•

•

•

•

•

•

•

•

•

•

•

•

•

•

•

•

•

•

•

•

•

•

•

•

•

•

•

•

•

•

•

•

•

•

•

•

•

•

•

•

•

•

•

•

•

•

•

•

•

•

•

•

•

•

•

•

•

•

•

•

•

•

•

•

•

•

•

•

•

•

•

•

•

•

•

•

•

•

•

•

•

•

•

•

•

•

•

•

•

•

•

•

•

•

•

•

•

•

•

•

•

•

•

•

•

•

•

•

•

•

•

•

WASHLET SG	GIOVANNONI	WASHLET GL 2.0	WASHLET EK 2.0	WASHLET CF
				
0.27 to 0.43 l/min	0.29 to 0.55 l/min	0.29 to 0.60 l/min	0.29 to 0.60 l/min	0.29 to 0.60 l/min
0.32 to 0.43 l/min		0.29 to 0.58 l/min	0.29 to 0.58 l/min	0.29 to 0.58 l/min
0.29 to 0.43 l/min	0.27 to 0.55 l/min	0.29 to 0.60 l/min	0.29 to 0.60 l/min	0.29 to 0.60 l/min
•				
	0.7 l	0.75 l	0.75 l	0.75 l
unlimited	40 seconds	40 seconds	40 seconds	40 seconds
30 to 40 °C	30 to 40 °C	30 to 40 °C	35 to 40 °C	30 to 40 °C
	approx. 10 min	approx. 10 min	approx. 10 min	approx. 10 min
28 to 36 °C	28 to 35 °C	28 to 36 °C	28 to 36 °C	28 to 36 °C
normal 0.09 m ³ /min, power 0.16 m ³ /min	normal 0.09 m ³ /min, power 0.16 m ³ /min	normal 0.09 m ³ /min, power 0.16 m ³ /min	normal 0.09 m ³ /min, power 0.16 m ³ /min	normal 0.09 m ³ /min, power 0.16 m ³ /min
35 to 55 °C approx. 0.29 m ³ /min		35 to 55 °C approx. 0.27 m ³ /min	35 to 55 °C approx. 0.27 m ³ /min	35 to 55 °C approx. 0.27 m ³ /min
•	•	•	•	•
1 to 10 bar	1 to 10 bar	1 to 10 bar	1 to 10 bar	1 to 10 bar
1,289–1,527 W	270–320 W	278–323 W	278–323 W	278–323 W
220–240 V / 50 HZ	222–240 V / 50 HZ	220–240 V / 50 HZ	220–240 V / 50 HZ	220–240 V / 50 HZ
•	•	•	•	•

WASHLET

NEOREST AC
incl. remote control

NEOREST EW
incl. remote control

WASHLET SG
incl. remote control



PLANNING DATA

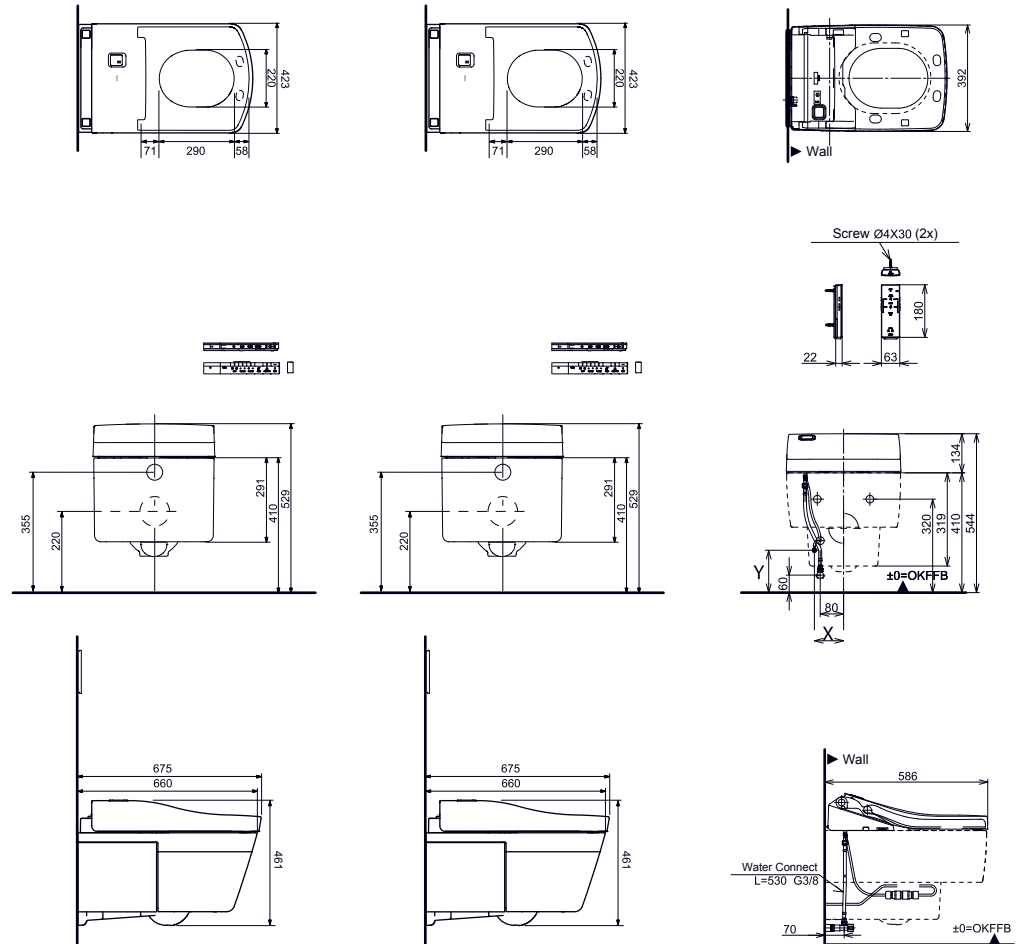

TECHNOLOGIES

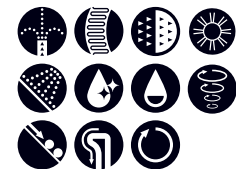

ARTICLE

- ▶ TCF996WG#NW1
- ▶ TCF996WSW#NW1 (CH)
- ▶ TCF996WGE#NW1 (UK)
- ▶ CW996P#NW1 WC

- ▶ TCF994WG#NW1
- ▶ TCF994WSW#NW1 (CH)
- ▶ TCF994WGE#NW1 (UK)
- ▶ CW994P#NW1 WC

- ▶ TCF403EGV1
- ▶ CW512Y WC

ACCESSORIES

required accessories: NEOREST AC, WC wallhung CW996P#NW1, Motor unit for automatic flushing E00004, for combination with push plate E00003 or push plate E00005 use pre-wall installation set 1,120 mm T9300048, 980 mm T9300051

required accessories: NEOREST EW, WC wallhung CW994P#NW1, Motor unit for automatic flushing E00004, for combination with push plate E00003 or push plate E00005 use pre-wall installation set 1,120 mm T9300048, 980 mm T9300051

required accessories: WC, wallhung CW512YR, Metallic cover 7EE0007 or Resin cover 9AE0017, we recommend pre-wall installation set, 1,120 mm T9300000 and upgrade set T9880039A

PRICE CATEGORY



WASHLET GIOVANNONI

incl. remote control

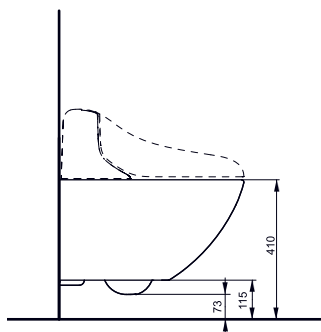
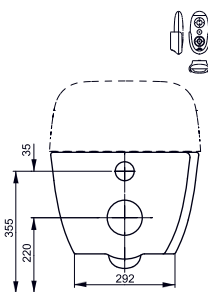
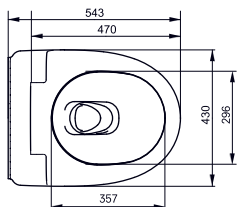

WASHLET GL 2.0

incl. remote control,
seat with soft closing function

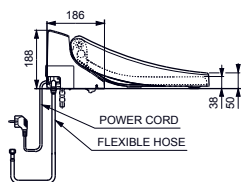
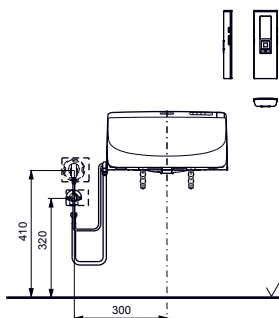
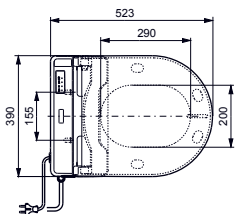

WASHLET EK 2.0

seat with soft closing function

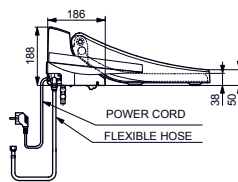
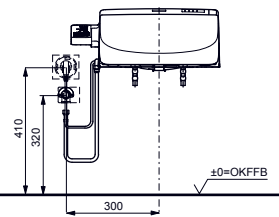
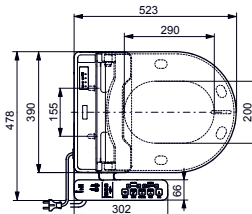

WASHLET CF

incl. remote control,
seat with soft closing function

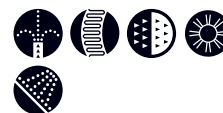
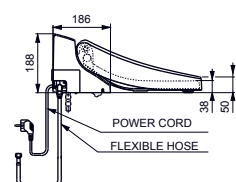
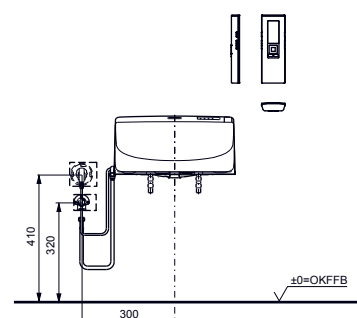
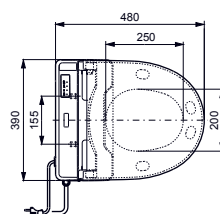

- ▶ TCF892G
- ▶ TCF892SW (CH)
- ▶ TCF892GE (UK)
- ▶ CW882Y WC

- ▶ TCF6512G#NW1
- ▶ TCF6512SW#NW1 (CH)
- ▶ TCF6512GE#NW1 (UK)

- ▶ TCF6612G#NW1
- ▶ TCF6612SW#NW1 (CH)
- ▶ TCF6612GE#NW1 (UK)

- ▶ TCF6510G#NW1
- ▶ TCF6510SW#NW1 (CH)
- ▶ TCF6510GE#NW1 (UK)

required accessories: Giovannoni WC, wallhung CW882Y, we recommend upgrade set T9880039, for combination with push plate E00022 use pre-wall installation set 1,120 mm T9300000, 980 mm T9300022 or 820 mm T9300001

can be combined with all TOTO WCs of NC and MH series, we recommend upgrade set T9880039, for combination with push plate E00022 use pre-wall installation set 1,120 mm T9300000, 980 mm T9300022 or 820 mm T9300001

can be combined with all TOTO WCs of NC and MH series, we recommend upgrade set T9880039, for combination with push plate E00022 use pre-wall installation set 1,120 mm T9300000, 980 mm T9300022 or 820 mm T9300001

required accessories: WC, wallhung CW132Y, we recommend upgrade set T9880039, for combination with push plate E00022 use pre-wall installation set 1,120 mm T9300000, 980 mm T9300022 or 820 mm T9300001



WHAT YOU SHOULD KNOW.

QUESTIONS AND ANSWERS.

WHAT TECHNICAL ASPECTS DO I NEED TO CONSIDER?

YOUR PLUMBER AND ELECTRICIAN NEED TO PROVIDE EXTRA POWER AND WATER CONNECTIONS IN ADVANCE.

CAN I UPGRADE MY TOILET TO A WASHLET?

IF YOU HAVE THE NECESSARY POWER AND WATER CONNECTIONS, IT IS POSSIBLE TO UPGRADE AT ANY TIME. PLEASE CONSULT THIS BROCHURE TO SEE WHICH WASHLETS FIT ON WHICH TOILETS.

WHO CAN INSTALL THE WASHLET?

TRAINED AND CERTIFIED PLUMBERS ARE FULLY CAPABLE OF INSTALLING WASHLETS.

WHERE CAN I TRY ONE?

USE THE WASHLET FINDER ON OUR WEBSITE (EU.TOTO.COM) TO SEE WHERE THE NEAREST PUBLICLY ACCESSIBLE WASHLET IS LOCATED.

HOW CAN I FIND THE CLOSEST PLUMBER OR RETAILER?

YOU CAN FIND RETAILERS AND CERTIFIED PLUMBERS ON OUR WEBSITE (EU.TOTO.COM).

WHY SHOULD I CHOOSE A TOTO WASHLET?

TOTO PRODUCES THE MOST TECHNICALLY SOPHISTICATED WASHLETS ON THE MARKET TODAY.

PUBLISHING DETAILS

PUBLISHED BY

TOTO Europe GmbH

info@totoeu.com

eu.toto.com

Authorised representatives:

Soichi Abe, Katsuyuki Kuramoto, Hiromoto Harano,
Managing Director

COPYRIGHT

2015, TOTO Europe GmbH

LAST REVISED

March 2015

CONCEPT DEVELOPMENT, EDITING AND DESIGN

PLEXGROUP, Berlin

TOTO Europe GmbH

PRINTING

Ruksaldruck GmbH + Co. KG, Berlin



TOTO Europe GmbH

Zollhof 2

40221 Düsseldorf

Germany

info@totoeu.com

eu.toto.com